

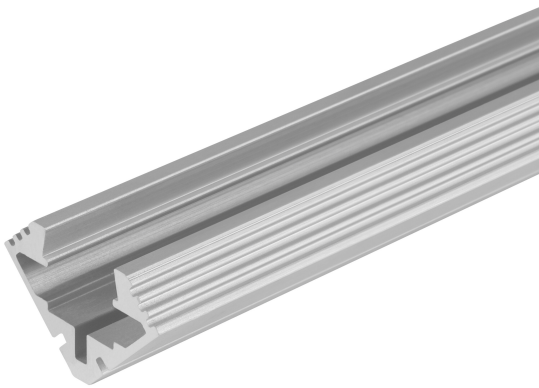

product_datasheet_title

LS AY -PM03/E/19X19/10/2

Medium Profiles for LED Strips | Medium Profiles for LED Strips



technical_data

DIMENSIONS & WEIGHT

| | |
|----------------|----------|
| Length | 2000 mm |
| Width | 19.0 mm |
| Height | 19.0 mm |
| Product weight | 580.00 g |

COLORS & MATERIALS

| | |
|---------------|------|
| Product color | Grey |
|---------------|------|

TEMPERATURES & OPERATING CONDITIONS

| | |
|--------------------------------|--------------|
| Ambient temperature range | -15...+45 °C |
| Temperature range in operation | -15...+45 °C |





ADDITIONAL PRODUCT DATA



| | |
|----------------|--|
| Product remark | Can be combined with SUPERIOR UNPROTECTED Strips / Cannot be combined with SUPERIOR PROTECTED Strips / Can be combined with PERFORMANCE UNPROTECTED Strips / Cannot be combined with PERFORMANCE PROTECTED Strips / Can be combined with VALUE UNPROTECTED Strips / Cannot be combined with VALUE PROTECTED Strips |
|----------------|--|

LOGISTICAL DATA

| | |
|------------------------------|--------------|
| Temperature range at storage | -35...+85 °C |
|------------------------------|--------------|

Accessories Optional

| product_image | product_name | product_ean |
|--|-------------------|---------------|
|  | LS AY -PC/P01/C/1 | 4058075402195 |
|  | LS AY -PM03/EC | 4058075277878 |
|  | LS AY -PM03/MB | 4058075276949 |
|  | LS AY -PC/P01/D/2 | 4058075401839 |

| product_image | product_name | product_ean |
|--|-------------------|---------------|
|  | LS AY -PC/P01/C/2 | 4058075402010 |
|  | LS AY -PC/P01/D/1 | 4058075279339 |
|  | LS AY -PM03/EC/H | 4058075277908 |

download_data

logistical_data

| product_code | packaging_unit | dimensions | weight | volume |
|---------------|--------------------|----------------------------|------------|-----------------------|
| 4058075401716 | BAG 1 | 2,000 mm x 22 mm x 12 mm | 581.00 g | 0.53 dm ³ |
| 4058075401723 | Bundle 5 | 2,000 mm x 22 mm x 60 mm | 2906.00 g | 2.64 dm ³ |
| 4058075401730 | Shipping box 25 | 2,040 mm x 155 mm x 110 mm | 15232.00 g | 34.78 dm ³ |

logistical_data_text

disclaimer_title

disclaimer_text