



product_datasheet_title

DL UGR19 PFM DN155 14 W 840 WT IP54 DALI

DOWNLIGHT UGR19 DALI | Low-glare downlights, suitable for computer screen workstations with DALI-2 IoT technology



technical_data

ELECTRICAL DATA

Nominal wattage	14.00 W
Nominal voltage	220...240 V
Mains frequency	0/50/60 Hz
Nominal current	154 mA
Inrush current	5 A
Inrush current time T_{h50}	200 μ s
Max. number of luminaires per miniature circuit breaker B16	120
Max. number of luminaires per miniature circuit breaker C10	80
Max. number of luminaires per miniature circuit breaker C16	120
Power factor λ	≥ 0.90
Total harmonic distortion	< 15 %
Protection class	II
Operating mode	External LED driver

PHOTOMETRICAL DATA

Luminous flux	1600 lm
Luminous efficacy	115 lm/W
Color temperature	4000 K
Light color (designation)	Cool White
Color rendering index Ra	≥ 80
Standard deviation of color matching	≤ 5 sdc _m
Luminous intensity	-
Low flicker	Yes
Flickering metric (Pst LM)	-
Stroboscope effect metric (SVM)	-
Photobiological safety group acc. to EN62778	RG1
Photobiological safety group acc. to EN62471	RG0
Beam angle	65 °
UGR	< 19

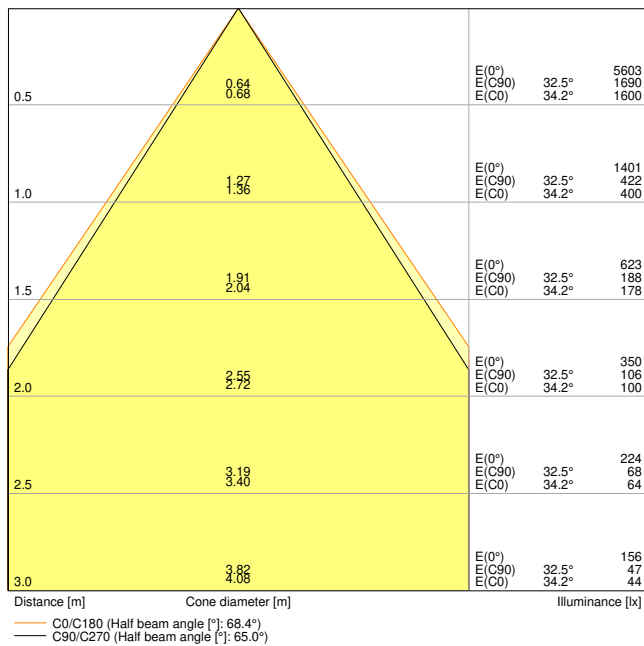

DL_UGR19_DN155_PFM_14W840_DALI_WT

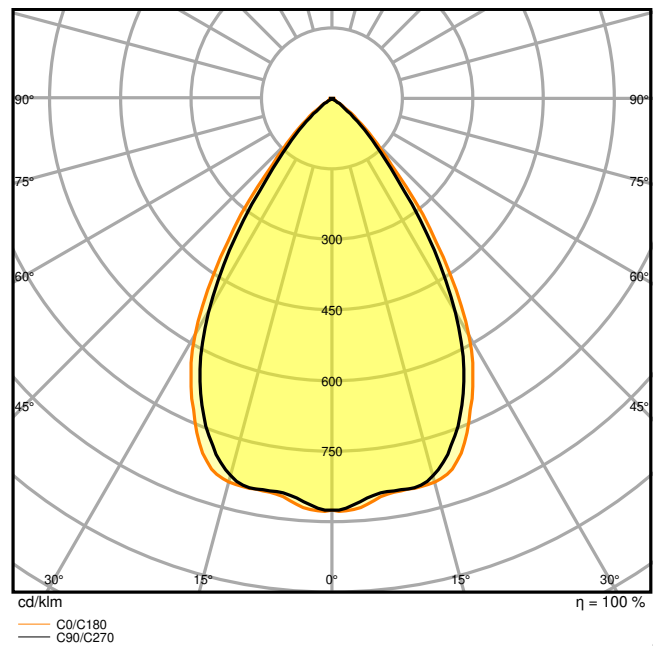

DL_UGR19_DN155_PFM_14W840_DALI_WT

DIMENSIONS & WEIGHT

Diameter	180.00 mm
Height	65.00 mm
Product weight	650.00 g

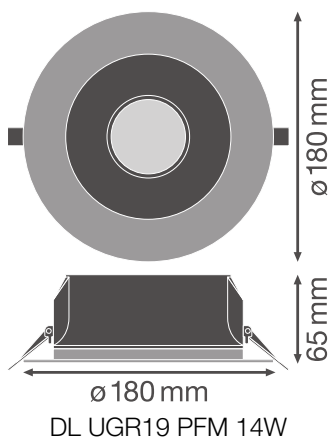

MATERIALS & COLORS

Product color	White
Housing color	White
Body material	Aluminum
Cover material	Polycarbonate (PC)
Light emitting surface material	Polycarbonate (PC)
Glow Wire Test according to IEC 60695-2-12	650 °C
Mercury content	0.0 mg

APPLICATION & MOUNTING

Ambient temperature range	-20...+45 °C
Temperature range at storage	-40...+70 °C
Type of connection	Screwless terminal, 5-Pole (L, N, PE, DA+, DA-)
Type of protection	IP54/IP20
Protection class IK (shock resistance)	IK03
Dimmable	yes
Type of dimming	DALI
Mounting type	Recessed
Mounting location	Ceiling
Application environment	Indoor
Mounting diameter	155,0 mm
Mounting depth	100 mm
LED module replaceable	Not replaceable
With light source	Yes

LIFESPAN

Lifespan L70/B50 at 25 °C	70000 h ¹⁾
Lifespan L80/B10 at 25 °C	60000 h ¹⁾
Lifespan L90/B10 at 25 °C	40000 h
Number of switching cycles	100000

¹⁾ t[h]: L70 / B50 @ 25 °C (Ta), t[h]: L80 / B10 @ 25 °C (Ta), t[h]: L90 / B10 @ 25 °C (Ta)

CONTROL GEAR

Output current	450 mA
ECG - Output ripple current	< 10 %
ECG - Length	119.0 mm
ECG - Width	52.0 mm

ECG - Height	30 mm
--------------	-------













CERTIFICATES & STANDARDS

Standards	CE / CB / ENEC / TÜV SÜD / EAC
Luminaire with limited surface temperature, "D sign"	No
Ball shot safe	No



ADDITIONAL PRODUCT DATA

Number of illuminants	Not relevant
-----------------------	--------------



download_data

Documents and certificates		document_name
	User instruction	DL UGR19 PFM
	Addon Technical Information	LSI DL UGR19 PFM
	Packaging insert	Legal insert DL UGR19 PFM
	Declarations Of Conformity CE	DL UGR19 DN155 PFM DALI WT
	Declarations Of Conformity UKCA	DL UGR19 PFM WT
Photometric and lighting design files		document_name
	IES file (IES)	DL UGR19 DN155 PFM 14W 840 DALI WT
	LDT file (Eulumdat)	DL UGR19 DN155 PFM 14W 840 DALI WT
	ULD file (DIALux)	DL UGR19 DN155 PFM 14W-840 DALI WT
	ROLF file (RELUX)	DL UGR19 DALI DN155 14W 840 WT IP54
	UGR file (UGR table)	DL UGR19 DN155 PFM 14W840 DALI WT
	UGR file (UGR table)	DL UGR19 DN155 PFM 14W 840 DALI WT
	UGR file (UGR table)	DL_UGR19_DN155_PFM_14W840_DALI_WT

Photometric and lighting design files document_name

	LDC typ cone	DL_UGR19_DN155_PFM_14W840_DALI_WT
	LDC typ polar	DL_UGR19_DN155_PFM_14W840_DALI_WT

CAD/BIM files document_name

	BIM_Revit_3D	DL UGR19
	CAD_STEP_3D	DL UGR19 14W

logistical_data

product_code	packaging_unit	dimensions	weight	volume
4058075459311	Folding box 1	215 mm x 84 mm x 219 mm	850.00 g	3.96 dm ³
4058075459328	Shipping box 24	526 mm x 449 mm x 468 mm	21806.00 g	110.53 dm ³

logistical_data_text

additional_catalog_information

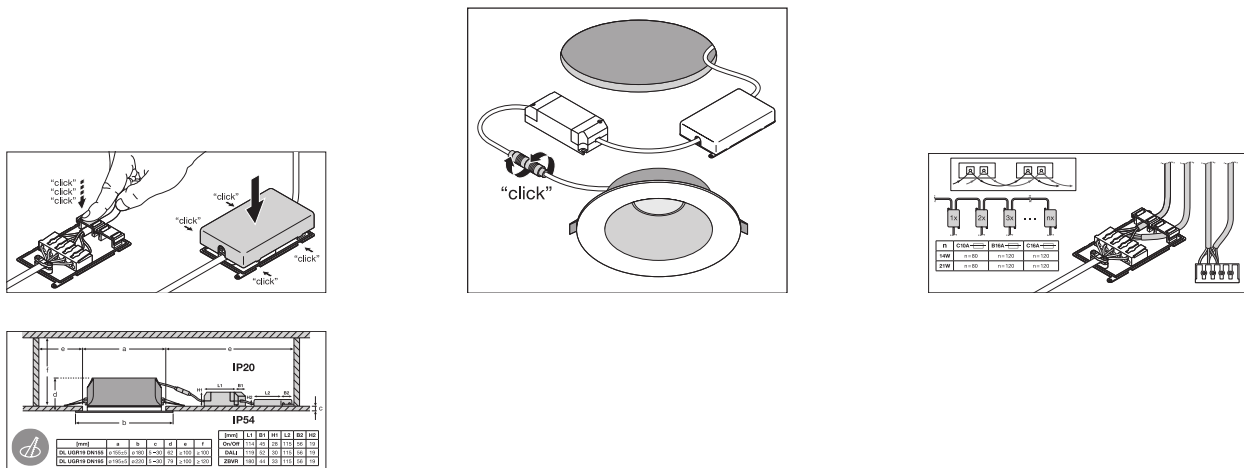

disclaimer_title

disclaimer_text